

PR
electronics



5714

**Programmable
LED Indicator**

No. 5714V103-UK
From serial number:
121496001 (A+B)
131077001 (C+D)



Distributed by:



Heinrich Kübler AG
Ruessenstrasse 4
CH-6340 Baar
Tel.: +41 (0)41 766 62 62
Fax: +41 (0)41 766 62 63
info@kubler.ch
www.kubler.ch

- DK** ▶ PR electronics A/S tilbyder et bredt program af analoge og digitale signalbehandlingsmoduler til industriel automation. Programmet består af Isolatorer, Displays, Ex-barrierer, Temperaturtransmittere, Universaltransmittere mfl. Vi har modulerne, du kan stole på i selv barske miljøer med elektrisk støj, vibrationer og temperaturudsving, og alle produkter opfylder de strengeste internationale standarder. Vores motto »Signals the Best« er indbegrebet af denne filosofi - og din garanti for kvalitet.
- UK** ▶ PR electronics A/S offers a wide range of analog and digital signal conditioning devices for industrial automation. The product range includes Isolators, Displays, Ex Interfaces, Temperature Transmitters, and Universal Devices. You can trust our products in the most extreme environments with electrical noise, vibrations and temperature fluctuations, and all products comply with the most exacting international standards. »Signals the Best« is the epitome of our philosophy - and your guarantee for quality.
- FR** ▶ PR electronics A/S offre une large gamme de produits pour le traitement des signaux analogiques et numériques dans tous les domaines industriels. La gamme de produits s'étend des transmetteurs de température aux afficheurs, des isolateurs aux interfaces SI, jusqu'aux modules universels. Vous pouvez compter sur nos produits même dans les conditions d'utilisation sévères, p.ex. bruit électrique, vibrations et fluctuations de température. Tous nos produits sont conformes aux normes internationales les plus strictes. Notre devise »SIGNALS the BEST« c'est notre ligne de conduite - et pour vous l'assurance de la meilleure qualité.
- DE** ▶ PR electronics A/S verfügt über ein breites Produktprogramm an analogen und digitalen Signalverarbeitungsgeräte für die industrielle Automatisierung. Dieses Programm umfasst Displays, Temperaturtransmitter, Ex- und galvanische Signaltrenner, und Universalgeräte. Sie können unsere Geräte auch unter extremen Einsatzbedingungen wie elektrisches Rauschen, Erschütterungen und Temperaturschwingungen vertrauen, und alle Produkte von PR electronics werden in Übereinstimmung mit den strengsten internationalen Normen produziert. »Signals the Best« ist Ihre Garantie für Qualität!

PROGRAMMABLE LED INDICATOR PREVIEW 5714

TABLE OF CONTENTS

Warning.....	2
Symbol identification	2
Safety instructions.....	3
Front and back layout.....	5
Application.....	6
Technical characteristics.....	6
Mounting.....	6
Applications.....	7
Order: 5714.....	8
Electrical specifications.....	8
Sensor error detection / sensor error detection outside range.....	12
Connections	14
Block diagram.....	15
Routing diagram.....	17
Scrolling help text	18
Configuration / operating the function keys.....	20
Graphic depiction of the relay function setpoint.....	21



GENERAL

WARNING

This device is designed for connection to hazardous electric voltages. Ignoring this warning can result in severe personal injury or mechanical damage. To avoid the risk of electric shock and fire, the safety instructions of this manual must be observed and the guidelines followed. The specifications must not be exceeded, and the device must only be applied as described in the following. Prior to the commissioning of the device, this manual must be examined carefully. Only qualified personnel (technicians) should install this device.

If the equipment is used in a manner not specified by the manufacturer, the protection provided by the equipment may be impaired.



**HAZARD-
OUS
VOLTAGE**



WARNING

Until the device is fixed, do not connect hazardous voltages to the device.

The following operations should only be carried out on a disconnected device and under ESD safe conditions:

Troubleshooting the device.

Repair of the device must be done by PR electronics A/S only.

SYMBOL IDENTIFICATION



Triangle with an exclamation mark: Warning / demand. Potentially lethal situations.



The CE mark proves the compliance of the device with the essential requirements of the directives.

SAFETY INSTRUCTIONS

DEFINITIONS:

Hazardous voltages have been defined as the ranges: 75 to 1500 Volt DC, and 50 to 1000 Volt AC.

Technicians are qualified persons educated or trained to mount, operate, and also troubleshoot technically correct and in accordance with safety regulations.

Operators, being familiar with the contents of this manual, adjust and operate the knobs or potentiometers during normal operation.

RECEIPT AND UNPACKING:

Unpack the device without damaging it. The packing should always follow the device until this has been permanently mounted. Check at the receipt of the device whether the type corresponds to the one ordered.

ENVIRONMENT:

Avoid direct sunlight, dust, high temperatures, mechanical vibrations and shock, as well as rain and heavy moisture. If necessary, heating in excess of the stated limits for ambient temperatures should be avoided by way of ventilation.

All devices fall under Installation Category II, Pollution Degree 1, and Insulation Class II.

MOUNTING:

Only technicians who are familiar with the technical terms, warnings, and instructions in the manual and who are able to follow these should connect the device. Should there be any doubt as to the correct handling of the device, please contact your local distributor or, alternatively,

PR electronics A/S
www.prelectronics.com

Mounting and connection of the device should comply with national legislation for mounting of electric materials, i.a. wire cross section, protective fuse, and location. Descriptions of Input / Output and supply connections are shown in the block diagram and side label.

The following apply to fixed hazardous voltages-connected devices:

The max. size of the protective fuse is 10 A and, together with a power switch, it should be easily accessible and close to the device. The power switch should be marked with a label telling it will switch off the voltage to the device.

UL INSTALLATION REQUIREMENTS:

For use on a flat surface of a type 1 enclosure

Use 60/75°C copper conductors only

Enclosure rating (face only)..... Type 4X, UL50E

Max. ambient temperature 60°C

Max. wire size, pins 41...46 AWG 30-16

Max. wire size, others AWG 30-12

UL file number E248256

CALIBRATION AND ADJUSTMENT:

During calibration and adjustment, the measuring and connection of external voltages must be carried out according to the specifications of this manual. The technician must use tools and instruments that are safe to use.

NORMAL OPERATION:

Operators are only allowed to adjust and operate devices that are safely fixed in panels, etc., thus avoiding the danger of personal injury and damage. This means there is no electrical shock hazard, and the device is easily accessible.

CLEANING:

When disconnected, the device may be cleaned with a cloth moistened with distilled water.

LIABILITY:

To the extent the instructions in this manual are not strictly observed, the customer cannot advance a demand against PR electronics A/S that would otherwise exist according to the concluded sales agreement.

FRONT AND BACK LAYOUT



Picture 1: Front of PReview 5714.

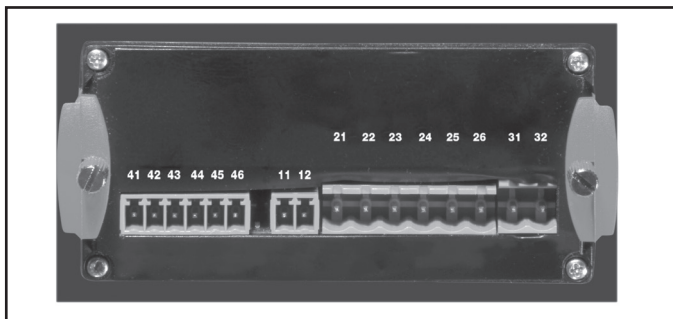

Picture 2: Back of PReview 5714.

PROGRAMMABLE LED INDICATOR PREVIEW 5714

- *4-digit 14-segment LED indicator*
- *Input for mA, V, potentiometer, Ohm, RTD and TC*
- *2 relays and analogue output*
- *Universal voltage supply*
- *Front key programmable*

Application

- Display for digital readout of current, voltage, resistance, temperature or potentiometer signals.
- Process control with 2 pairs of potential-free relays and / or analogue output.
- For local readout in extremely wet atmospheres with a specially designed splash-proof cover.

Technical characteristics

- 4-digit LED indicator with 13.8 mm 14-segment characters. Max. display readout -1999...9999 with programmable decimal point, relay ON / OFF indication.
- All operational parameters can be adjusted to any application by use of the front keys.
- PReview 5714 is available fully-configured acc. to specifications ready for process control and visualisation.
- Help texts in eight languages can be selected via a menu item.
- In versions with relay outputs the user can minimise the installation test time by activating / deactivating each relay independently of the input signal.

Mounting

- To be mounted in front panel. The included rubber packing must be mounted between the panel cutout hole and the display front to obtain a protection degree of IP65 (type 4X). For extra protection in extreme environments, PReview 5714 can be delivered with a specially designed splash-proof cover as accessory.

APPLICATIONS

Input signals:

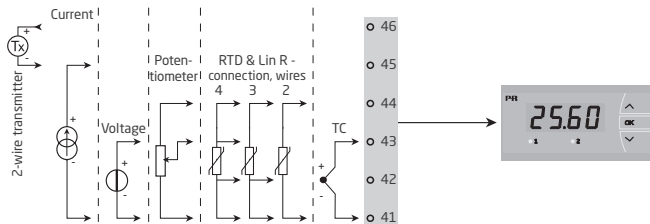

Output signals:

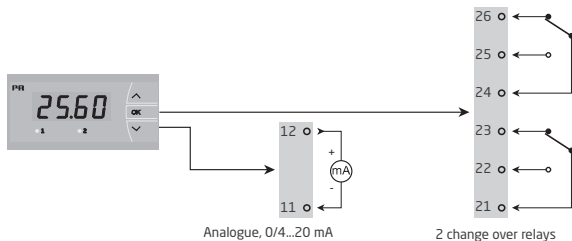

Supply:

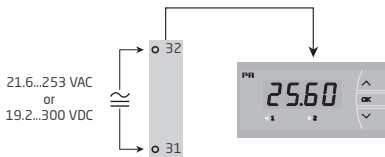

Order: 5714

Type	Version
5714	Standard..... : A 2 relays..... : B Analogue output..... : C Analogue output and 2 relays.... : D

NB! Please order the splash-proof cover separately. Order No. 8335.

Electrical specifications

Specifications range:

-20°C to +60°C

Common specifications:

Supply voltage, universal..... 21.6...253 VAC, 50...60 Hz or
19.2...300 VDC

Consumption

Type	Internal consumption	Max. consumption
5714A	2.2 W	2.5 W
5714B/C	2.7 W	3.0 W
5714D	3.2 W	3.5W

Isolation voltage, test / operation..... 2.3 kVAC / 250 VAC

Signal- / noise ratio..... Min. 60 dB (0...100 kHz)

Response time (0...90 %, 100...10 %), programmable:

Temperature input..... 1...60 s

Current / voltage input..... 0.4...60 s

Calibration temperature..... 20...28°C

Accuracy, the greater of general and basic values:

General values		
Input type	Absolute accuracy	Temperature coefficient
All	≤ ±0.1% of reading	≤ ±0.01% of reading / °C

Basic values		
Input type	Basic accuracy	Temperature coefficient
mA	$\leq \pm 4 \mu\text{A}$	$\leq \pm 0.4 \mu\text{A} / ^\circ\text{C}$
Volt	$\leq \pm 20 \mu\text{V}$	$\leq \pm 2 \mu\text{V} / ^\circ\text{C}$
Pt100	$\leq \pm 0.2^\circ\text{C}$	$\leq \pm 0.01^\circ\text{C} / ^\circ\text{C}$
Linear resistance	$\leq \pm 0.1 \Omega$	$\leq \pm 0.01 \Omega / ^\circ\text{C}$
Potentiometer	$\leq \pm 0.1 \Omega$	$\leq \pm 0.01 \Omega / ^\circ\text{C}$
TC type: E, J, K, L, N, T, U	$\leq \pm 1^\circ\text{C}$	$\leq \pm 0.05^\circ\text{C} / ^\circ\text{C}$
TC type: R, S, W3, W5, LR	$\leq \pm 2^\circ\text{C}$	$\leq \pm 0.2^\circ\text{C} / ^\circ\text{C}$
TC type: B 85...200°C	$\leq \pm 4^\circ\text{C}$	$\leq \pm 0.4^\circ\text{C} / ^\circ\text{C}$
TC type: B 200...1820°C	$\leq \pm 2^\circ\text{C}$	$\leq \pm 0.2^\circ\text{C} / ^\circ\text{C}$
EMC immunity influence < $\pm 0.5\%$ of readout		

Auxiliary supply:

2 wire supply, pin 46...45	25...15 VDC / 0...20 mA
Vibration	IEC 60068-2-6 Test FC
2...25 Hz	$\pm 1.6 \text{ mm}$
25...100 Hz	$\pm 4 \text{ g}$
Wire size, pin 41...46 max.	1 x 1.5 mm ² stranded wire
Wire size, others max.	1 x 2.5 mm ² stranded wire
Relative humidity	< 95% RH (non cond.)
Dimensions (HxWxD)	48 x 96 x 120 mm
Cutout dimensions	44.5 x 91.5 mm
Protection degree (mounted in panel)	IP65 / Type 4X, UL50E
Weight	230 g

RTD, linear resistance and potentiometer input:

Input type	Min. value	Max. value	Standard
Pt10...Pt1000	-200°C	+850°C	IEC 60751
Ni50...Ni1000	-60°C	+250°C	DIN 43760
Cu10...Cu100	-200°C	+260°C	$\alpha = 0.00427$
Lin. R	0 Ω	10000 Ω	-
Potentiometer	10 Ω	100 k Ω	-

Input for RTD types:

Pt10, Pt20, Pt50, Pt100, Pt200, Pt250, Pt300, Pt400, Pt500, Pt1000

Ni50, Ni100, Ni120, Ni1000, Cu10, Cu20, Cu50, Cu100

Cable resistance pr. wire, RTD (max.)..... 50 Ω

Sensor current, RTD..... Nom. 0.2 mA

Effect of sensor cable resistance

(3- / 4-wire), RTD < 0.002 Ω / Ω

Sensor error detection, RTD..... Yes

Short circuit detection, RTD..... < 15 Ω

TC input:

Type	Min. value	Max. value	Standard
B	0°C	+1820°C	IEC 60584-1
E	-100°C	+1000°C	IEC 60584-1
J	-100°C	+1200°C	IEC 60584-1
K	-180°C	+1372°C	IEC 60584-1
L	-200°C	+900°C	DIN 43710
N	-180°C	+1300°C	IEC 60584-1
R	-50°C	+1760°C	IEC 60584-1
S	-50°C	+1760°C	IEC 60584-1
T	-200°C	+400°C	IEC 60584-1
U	-200°C	+600°C	DIN 43710
W3	0°C	+2300°C	ASTM E988-90
W5	0°C	+2300°C	ASTM E988-90
LR	-200°C	+800°C	GOST 3044-84

Cold junction compensation (CJC)

via internal sensor $\pm(2.0^{\circ}\text{C} + 0.4^{\circ}\text{C} * \Delta t)$

Δt = internal temperature - ambient temperature

Sensor error detection, all TC types..... Yes

Sensor error detection..... Yes

Sensor error current:

when detecting..... Nom. 2 μA

else..... 0 μA

Current input:

Measurement range..... 0...20 mA

Programmable measurement ranges..... 0...20 and 4...20 mA

Input resistance..... Nom. 20 Ω + PTC 25 Ω

Sensor error detection:

loop break 4...20 mA..... Yes

Voltage input:

Measurement range.....	0...12 VDC
Programmable measurement ranges.....	0...1 / 0.2...1 / 0...10 / 2...10 VDC
Input resistance.....	Nom. 10 M Ω

Outputs:**Display:**

Display readout.....	-1999...9999 (4 digits)
Decimal point.....	Programmable
Digit height	13.8 mm
Display updating	2.2 times / s
Input outside input range is indicated by.....	Explanatory text

Current output:

Signal range (span)	0...20 mA
Programmable signal ranges.....	0...20 / 4...20 / 20...0 / 20...4 mA
Load (max.).....	20 mA / 800 Ω / 16 VDC
Load stability.....	\leq 0.01% of span / 100 Ω
Sensor error detection.....	0 / 3.5 / 23 mA / none & NAMUR NE 43 up / downscale.....
Output limitation:	
on 4...20 and 20...4 mA signals	3,8...20.5 mA
on 0...20 and 20...0 mA signals	0...20.5 mA
Current limit	\leq 28 mA

Relay outputs:

Relay function.....	Setpoint
Hysteresis.....	0...100%
On and Off delay.....	0...3600 s
Sensor error detection.....	Make / Break / Hold
Max. voltage	250 VRMS
Max. current.....	2 A / AC
Max. AC power	500 VA
Max. current at 24 VDC.....	1 A

Marine approval:

Det Norske Veritas, Ships & Offshore.....	Standard for Certification No. 2.4
---	------------------------------------

Observed authority requirements: Standard:

EMC 2004/108/EC	EN 61326-1
LVD 2006/95/EC.....	EN 61010-1
UL, Standard for Safety	UL 508
EAC TR-CU 020/2011.....	EN 61326-1

Sensor error detection / sensor error detection outside range

Sensor error check in 5714 variants		
Variant:	Configuration	Sensor error detection:
5714A	Always:	ON
5714B	ERR1=NONE, ERR2=NONE:	OFF
	else:	ON
5714C	O.ERR=NONE:	OFF
	else:	ON
5714D	ERR1=NONE, ERR2=NONE, O.ERR=NONE:	OFF
	else:	ON

Outside range readout (IN.LO, IN.HI): If the valid range of the A/D converter or the polynomial is exceeded			
Input	Range	Readout	Limit
VOLT	0...1 V / 0,2...1 V	IN.LO	< -25 mV
		IN.HI	> 1,2 V
	0...10 V / 2...10 V	IN.LO	< -25 mV
		IN.HI	> 12 V
CURR	0...20 mA / 4...20 mA	IN.LO	< -1,05 mA
		IN.HI	> 25,05 mA
POTM	-	IN.LO	< -0,5%
		IN.HI	> 100,5%
TEMP	TC / RTD	IN.LO	< temperature range -2°C
		IN.HI	> temperature range +2°C
LIN R	0...800 ohm	IN.LO	< 0 ohm
		IN.HI	> 1 kohm
	0...10 kohm	IN.LO	< 0 ohm
		IN.HI	> 15 kohm

Sensor error detection (SE.BR, SE.SH):			
Input	Range	Readout	Limit
CURR	Loop break (4...20mA)	SE.BR	<= 3,6 mA; > = 21 mA
TEMP	TC RTD, 2-, 3- & 4-wire No SE.SH for Cuxx, Pt10, Pt20 & Pt50	SE.BR	> ca. 750 kohm / (1,25 V)
		SE.BR	> 12 kohm
		SE.SH	< 15 ohm
LIN R	0...800 ohm	SE.BR	> 875 ohm
	0...10 kohm	SE.BR	> 12 kohm

Display readout below min. / above max. (-1.9.9.9, 9.9.9.9):			
Input	Range	Readout	Limit
CURR VOLT	All	-1.9.9.9	Display readout < -1999
		9.9.9.9	Display readout > 9999
LIN R	All	-1.9.9.9	Display readout < -1999
		9.9.9.9	Display readout > 9999
POTM	-	-1.9.9.9	Display readout < -1999
		9.9.9.9	Display readout > 9999

Readout at hardware error		
Error search	Readout	Error cause
Test of internal communication uC / ADC	HW.ER	Permanent error in ADC
Test of internal CJC sensor	CJ.ER	CJC sensor defect
Check-sum test of the configuration in RAM	RA.ER	Error in RAM
Check-sum test of the configuration in EEPROM	EE.ER	Error in EEPROM

! Error indications in the display blink once a second. The help text explains the error.

CONNECTIONS

Inputs:

RTD & Lin R, 2-wire

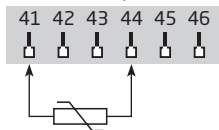

RTD & Lin R, 3-wire

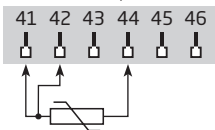

RTD & Lin R, 4-wire

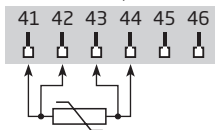

TC

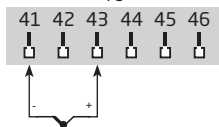

2-wire transmitter

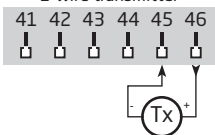

Current

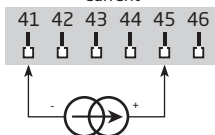

Voltage

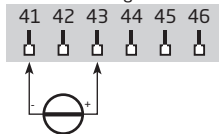

Potentiometer

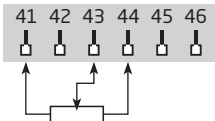

Supply:

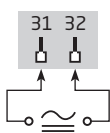

Current

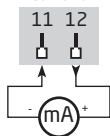

Output:

Relays

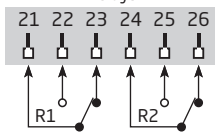

BLOCK DIAGRAM

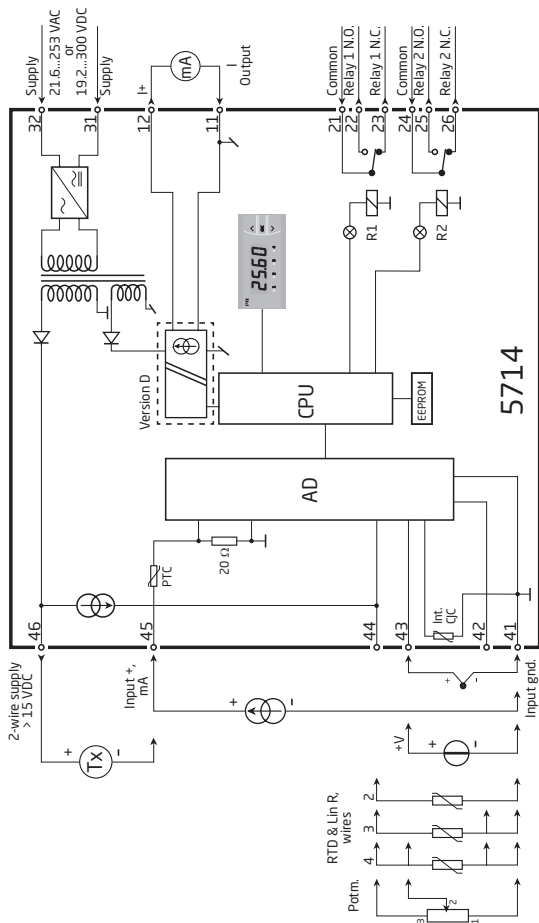

Power up

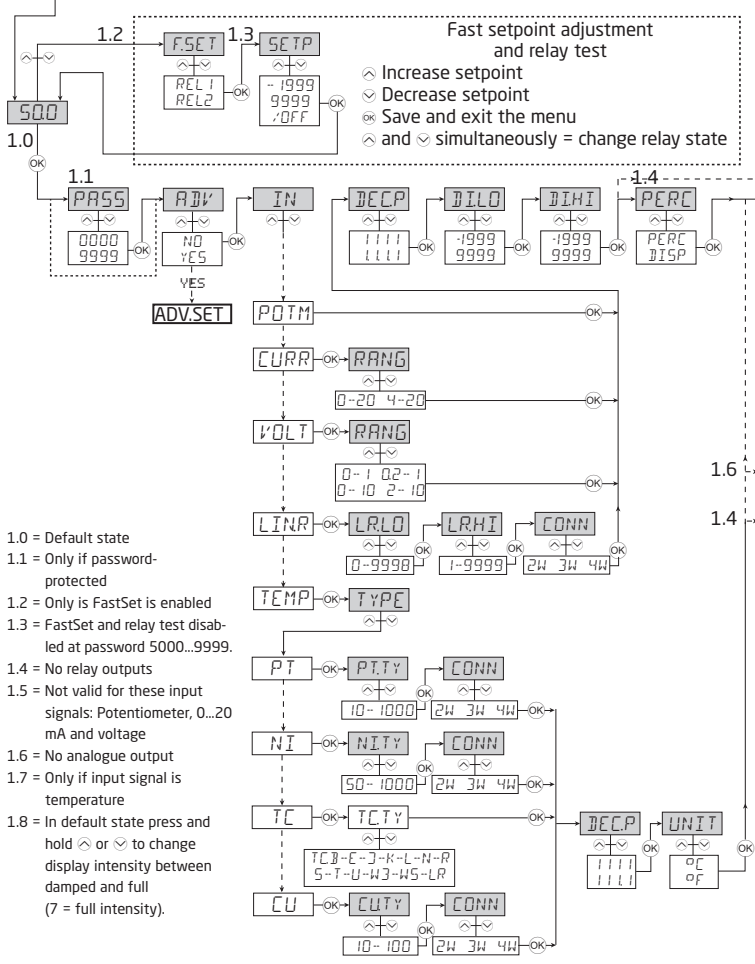

ROUTING DIAGRAM

If no keys are activated for 2 minutes the display returns to default state 1.0 without saving configuration changes..

⬆ Increase value / choose next parameter

⬇ Decrease value / choose previous parameter

⊙ Accept the chosen parameter and go to the next menu

Hold ⊙ Back to previous menu / return to menu 1.0 without saving

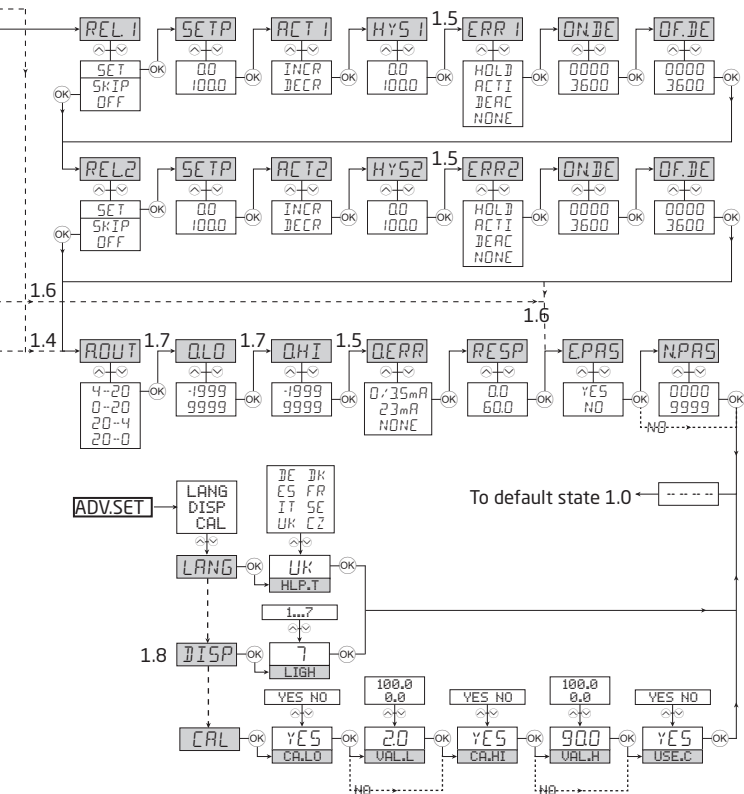

SCROLLING HELP TEXT

Display in default state xxxx, hardware error:

SE.BR --> SENSOR WIRE BREAKAGE
SE.SH --> SENSOR SHORT CIRCUIT
IN.HI --> INPUT OVERRANGE
IN.LO --> INPUT UNDERRANGE
9.9.9.9 --> DISPLAY OVERRANGE
-1.9.9.9 --> DISPLAY UNDERRANGE
Hw.ER --> HARDWARE ERROR
EE.ER --> EEPROM ERROR -
CHECK CONFIGURATION
RA.ER --> RAM MEMORY ERROR
CJ.ER --> CJC SENSOR ERROR

Fastset (Enabled):

F.SET
REL1 --> FAST SET MENU -
REL2 --> SELECT RELAY
SETP
xxxx --> RELAY SETPOINT - PRESS OK TO SAVE

Fastset (Disabled):

SETP
xxxx --> RELAY SETPOINT - READ ONLY

Configuration menus:

ADV
YES --> ENTER ADVANCED SETUP MENU?
NO

PASS
xxxx --> SET CORRECT PASSWORD

IN
CLIN* --> TEXT ENTERED BY USER IN PRESET
CURR --> CURRENT INPUT
VOLT --> VOLTAGE INPUT
POTM --> POTENTIOMETER INPUT
LIN.R --> LINEAR RESISTANCE INPUT
TEMP --> TEMPERATURE SENSOR INPUT

RANG **When current selected:**
0-20 --> INPUT RANGE IN mA
4-20 --> INPUT RANGE IN mA

RANG **When voltage selected:**
0-10 --> INPUT RANGE IN VOLT
2-10 --> INPUT RANGE IN VOLT
0.0-1 --> INPUT RANGE IN VOLT
0.2-1 --> INPUT RANGE IN VOLT

DEC.P
1111 --> DECIMAL POINT POSITION
111.1 --> DECIMAL POINT POSITION
11.11 --> DECIMAL POINT POSITION
1.111 --> DECIMAL POINT POSITION

LR.LO
xxxx --> SET RESISTANCE VALUE LOW

LR.HI
xxxx --> SET RESISTANCE VALUE HIGH

DI.LO
xxxx --> DISPLAY READOUT LOW

DI.HI
xxxx --> DISPLAY READOUT HIGH

REL.U
PERC --> SET RELAY IN PERCENTAGE
DISP --> SET RELAY IN DISPLAY UNITS

TYPE
CU --> SELECT CU SENSOR TYPE
PT --> SELECT PT SENSOR TYPE
NI --> SELECT NI SENSOR TYPE
TC --> SELECT TC SENSOR TYPE

CU.TY
10 --> SELECT CU SENSOR TYPE
20 --> SELECT CU SENSOR TYPE
50 --> SELECT CU SENSOR TYPE
100 --> SELECT CU SENSOR TYPE

PT.TY
10 --> SELECT PT SENSOR TYPE
20 --> SELECT PT SENSOR TYPE
50 --> SELECT PT SENSOR TYPE
100 --> SELECT PT SENSOR TYPE
200 --> SELECT PT SENSOR TYPE
250 --> SELECT PT SENSOR TYPE
300 --> SELECT PT SENSOR TYPE
400 --> SELECT PT SENSOR TYPE
500 --> SELECT PT SENSOR TYPE
1000 --> SELECT PT SENSOR TYPE

NI.TY
50 --> SELECT NI SENSOR TYPE
100 --> SELECT NI SENSOR TYPE
120 --> SELECT NI SENSOR TYPE
1000 --> SELECT NI SENSOR TYPE

CONN **When Cu, Pt and Ni sensor is selected**
2W --> SELECT 2-WIRE SENSOR CONNECTION
3W --> SELECT 3-WIRE SENSOR CONNECTION
4W --> SELECT 4-WIRE SENSOR CONNECTION

TC.TY
TC.B --> SELECT TC SENSOR TYPE
TC.E --> SELECT TC SENSOR TYPE
TC.J --> SELECT TC SENSOR TYPE
TC.K --> SELECT TC SENSOR TYPE
TC.L --> SELECT TC SENSOR TYPE
TC.N --> SELECT TC SENSOR TYPE
TC.R --> SELECT TC SENSOR TYPE
TC.S --> SELECT TC SENSOR TYPE
TC.T --> SELECT TC SENSOR TYPE
TC.U --> SELECT TC SENSOR TYPE
TC.W3 --> SELECT TC SENSOR TYPE
TC.W5 --> SELECT TC SENSOR TYPE
TC.LR --> SELECT TC SENSOR TYPE

DEC.P **When temperature selected**
1111 --> DECIMAL POINT POSITION
111.1 --> DECIMAL POINT POSITION

UNIT
°C --> DISPLAY AND RELAY SETUP IN CELSIUS
°F --> DISPLAY AND RELAY SETUP IN FAHRENHEIT

REL1			
SET	-->	ENTER RELAY 1 SETUP	
SKIP	-->	SKIP RELAY 1 SETUP	
OFF	-->	RELAY 1 DISABLED	
SETP			
xxxx	-->	RELAY SETPOINT	
ACT1			
INCR	-->	ACTIVATE AT INCREASING SIGNAL	
DECR	-->	ACTIVATE AT DECREASING SIGNAL	
HYS1			
xxxx	-->	RELAY HYSTERESIS	
ERR1			
HOLD	-->	HOLD RELAY AT ERROR	
ACTI	-->	ACTIVATE RELAY AT ERROR	
DEAC	-->	DEACTIVATE RELAY AT ERROR	
NONE	-->	UNDEFINED STATUS AT ERROR	
ON.DE			
xxxx	-->	RELAY ON-DELAY IN SECONDS	
OF.DE			
xxxx	-->	RELAY OFF-DELAY IN SECONDS	
REL2			
SET	-->	ENTER RELAY 2 SETUP	
SKIP	-->	SKIP RELAY 2 SETUP	
OFF	-->	RELAY 2 DISABLED	
SETP			
xxxx	-->	RELAY SETPOINT	
ACT2			
INCR	-->	ACTIVATE AT INCREASING SIGNAL	
DECR	-->	ACTIVATE AT DECREASING SIGNAL	
HYS2			
xxxx	-->	RELAY HYSTERESIS	
ERR2			
HOLD	-->	HOLD RELAY AT ERROR	
ACTI	-->	ACTIVATE RELAY AT ERROR	
DEAC	-->	DEACTIVATE RELAY AT ERROR	
NONE	-->	UNDEFINED STATUS AT ERROR	
ON.DE			
xxxx	-->	RELAY ON-DELAY IN SECONDS	
OF.DE			
xxxx	-->	RELAY OFF-DELAY IN SECONDS	
A.OUT			
0-20	-->	OUTPUT RANGE IN mA	
4-20	-->	OUTPUT RANGE IN mA	
20-0	-->	OUTPUT RANGE IN mA	
20-4	-->	OUTPUT RANGE IN mA	
O.LO			
xxxx	-->	DISPLAY VALUE FOR OUTPUT LOW	
O.HI			
xxxx	-->	DISPLAY VALUE FOR OUTPUT HIGH	
O.ERR			
23 mA	-->	NAMUR NE43 UPSCALE AT ERROR	
3,5 mA	-->	NAMUR NE43 DOWNSCALE AT ERROR	
0mA	-->	DOWNSCALE AT ERROR	
NONE	-->	UNDEFINED OUTPUT AT ERROR	
RESP			
xxx.x	-->	ANALOGUE OUTPUT RESPONSE TIME IN SECONDS	
E.PAS			
NO	-->	ENABLE PASSWORD PROTECTION	
YES			
N.PAS			
xxxx	-->	SELECT NEW PASSWORD	
ADV MENU:			
LANG	-->	ENTER LANGUAGE SETUP	
DISP	-->	ENTER DISPLAY SETUP	
CAL	-->	PERFORM PROCESS CALIBRATION	
HLPT			
DE	-->	DE - WAEHLE DEUTSCHEN HILFETEXT	
DK	-->	DK - VAE LG DANSK HJAE LPETEKST	
ES	-->	ES - SELECCIONAR TEXTO DE AYUDA EN ESPANOL	
FR	-->	FR - SELECTION TEXTE D'AIDE EN FRANCAIS	
IT	-->	IT - SELEZIONARE TESTI DI AIUTO ITALIANI	
SE	-->	SE - VALJ SVENSK HJALPTEXT	
UK	-->	UK - SELECT ENGLISH HJALPTEXT	
CZ	-->	CZ - VYBER CESKOU NAPOVEDU	
LIGH			
xxxx	-->	ADJUST DISPLAY LIGHT INTENSITY	
CA.LO			
YES	-->	CALIBRATE INPUT LOW TO PROCESS VALUE?	
NO			
CA.HI			
YES	-->	CALIBRATE INPUT HIGH TO PROCESS VALUE?	
NO			
VAL.L			
xxxx	-->	SET VALUE FOR LOW CALIBRATION POINT	
VAL.H			
xxxx	-->	SET VALUE FOR HIGH CALIBRATION POINT	
USE.C			
YES	-->	USE PROCESS CALIBRATED VALUES?	
NO			

CONFIGURATION / OPERATING THE FUNCTION KEYS

Documentation for routing diagram.

In general:

When configuring the display you are guided through all parameters, you can choose the settings which fit the application. For each menu there is a scrolling help text which is automatically shown in the display, this starts after 5 seconds if no key has been activated.

Configuration is carried out by using the 3 function keys.

- ⬆ will increase the numerical value or choose the next parameter.
- ⬇ will decrease the numerical value or choose the previous parameter.
- OK will accept the chosen value and end the menu.

If a function does not exist in the display all parameters are skipped to make the configuration as simple as possible.

Once the configuration has been entered the display will show "----".

Pressing and holding OK will return to the previous menu or return to the default state (1.0) without saving the changed values or parameters.

If no key is activated for 2 minutes, the display will return to the default state (1.0) without saving the changed values or parameters.

Further explanations:

Fast setpoint adjustment and relay test: These menus allow you to change the set point quickly and to check the operation of the relays.

Pressing ⬆ and ⬇ at the same time will change the state of the relay - this change is indicated by the diodes on the display. Pressing OK will save the set point change.

Holding down OK for more than 0.5 seconds will return the unit to the default state without changing the set point.

Password protection:

Using a password will stop access to the menu and parameters. There are two levels of password protection. Passwords between 0000...4999 allow access to the fast set point adjustment and relay test. (Using this password stops access to all other parts of the menu). Passwords between 5000...9999 stop access to all parts of the menu, fast set point and relay test. (Current set point is still shown). By using the master password 2008, all configuration menus are available.

Graphic depiction of the relay function setpoint

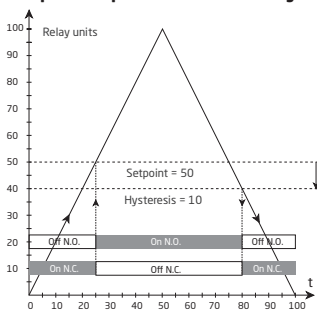

Relay action: Increasing

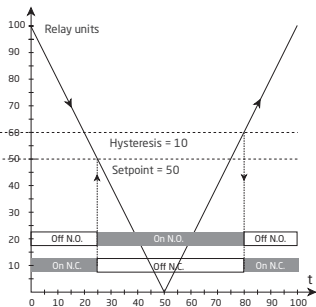

Relay action: Decreasing



Displays Programmable displays with a wide selection of inputs and outputs for display of temperature, volume and weight, etc. Feature linearization, scaling, and difference measurement functions for programming via PReset software.



Ex interfaces Interfaces for analog and digital signals as well as HART® signals between sensors / I/P converters / frequency signals and control systems in Ex zone 0, 1 & 2 and for some devices in zone 20, 21 & 22.



Isolation Galvanic isolators for analog and digital signals as well as HART® signals. A wide product range with both loop-powered and universal isolators featuring linearization, inversion, and scaling of output signals.





























Temperature A wide selection of transmitters for DIN form B mounting and DIN rail devices with analog and digital bus communication ranging from application-specific to universal transmitters.



Universal PC or front programmable devices with universal options for input, output and supply. This range offers a number of advanced features such as process calibration, linearization and auto-diagnosis.



- 

www.preelectronics.fr

sales-fr@preelectronics.com
- 

www.preelectronics.de

sales-de@preelectronics.com
- 

www.preelectronics.es

sales-es@preelectronics.com
- 

www.preelectronics.it

sales-it@preelectronics.com
- 

www.preelectronics.se

sales-se@preelectronics.com
- 

www.preelectronics.com

sales-uk@preelectronics.com
- 

www.preelectronics.com

sales-us@preelectronics.com
- 

www.preelectronics.cn

sales-cn@preelectronics.com
- 

www.preelectronics.be

sales-be@preelectronics.com

Head office

Denmark
 PR electronics A/S
 Lerbakken 10
 DK-8410 Rønne

www.preelectronics.com
sales-dk@preelectronics.com
 tel. +45 86 37 26 77
 fax +45 86 37 30 85



QUALITY SYSTEM AND ENVIRONMENTAL
 MANAGEMENT SYSTEM
 DS/EN ISO 9001
 DS/EN ISO 14001

